

MODEL DESCRIPTION CIMA FIXED FRAME	MODEL # CIF094DNEVEWPX	SCREEN MATERIAL: NEVE	FRAME COLOR: VELUX	BATTEN COLOR: N/A	MOUNTING: WALL	APPROXIMATE WEIGHT: 30 LBS.	RESTRICTION: The information contained in the proposal is confidential and proprietary to Stewart Filmscreen Corporation, shall not be disclosed beyond the client company, and shall not be duplicated, used, or disclosed in whole or in part for any purpose except to evaluate this proposal.
CUSTOMER ACCEPTANCE:	DATE:	DRAWING DATE: 5/24/2013	PERFORATION: PERFORADO	DRAWN BY: J. LAUB	SHEET: 1 OF 3	CONTROL(S): N/A	

Cima™
by Stewart Filmscreen

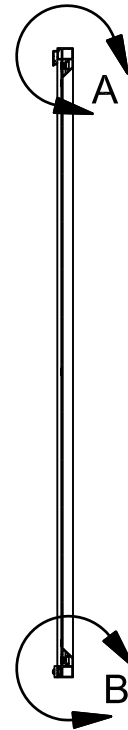

SECTION A-A

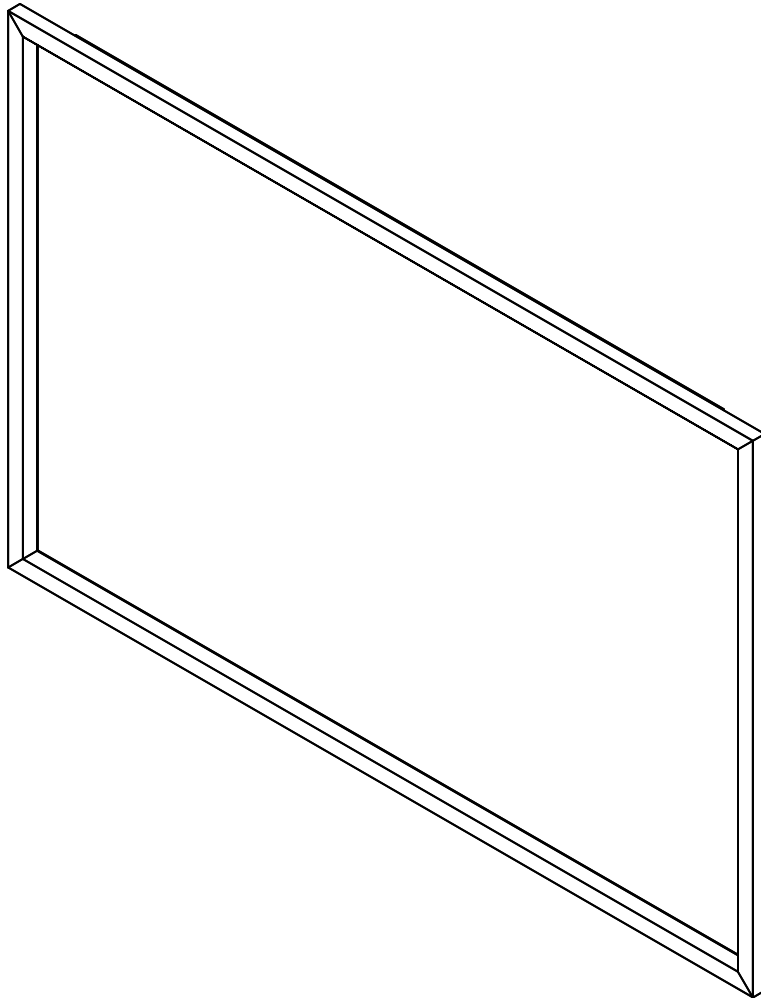
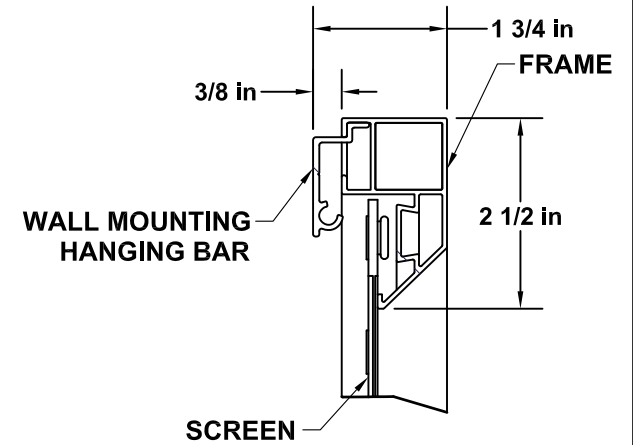

DETAIL A

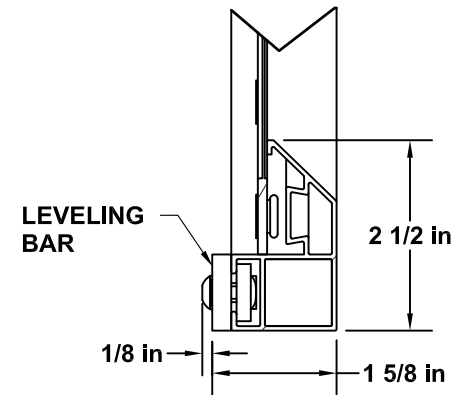

DETAIL B

MODEL DESCRIPTION CIMA FIXED FRAME	MODEL # CIF094DNEVEWPX	SCREEN MATERIAL: NEVE	FRAME COLOR: VELUX	BATTEN COLOR: N/A	MOUNTING: WALL	APPROXIMATE WEIGHT: 30 LBS.	RESTRICTION: The information contained in the proposal is confidential and proprietary to Stewart Filmscreen Corporation, shall not be disclosed beyond the client company, and shall not be duplicated, used, or disclosed in whole or in part for any purpose except to evaluate this proposal.
CUSTOMER ACCEPTANCE:	DATE:	DRAWING DATE: 5/24/2013	PERFORATION: PERFORADO	DRAWN BY: J. LAUB	SHEET: 2 OF 3	CONTROL(S): N/A	

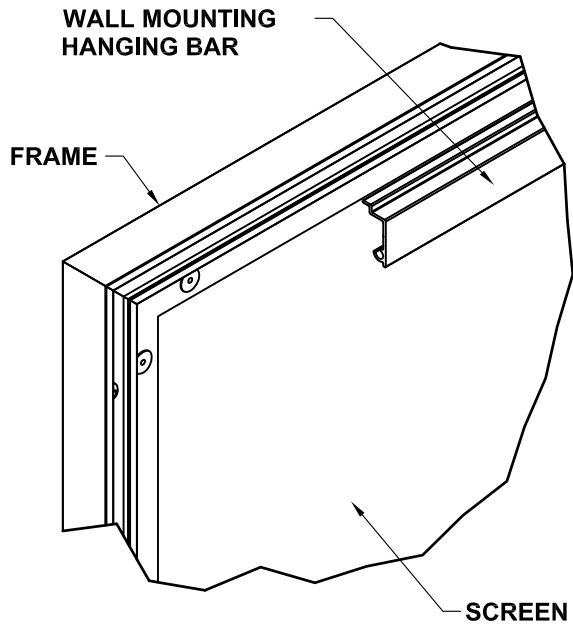

DETAIL C

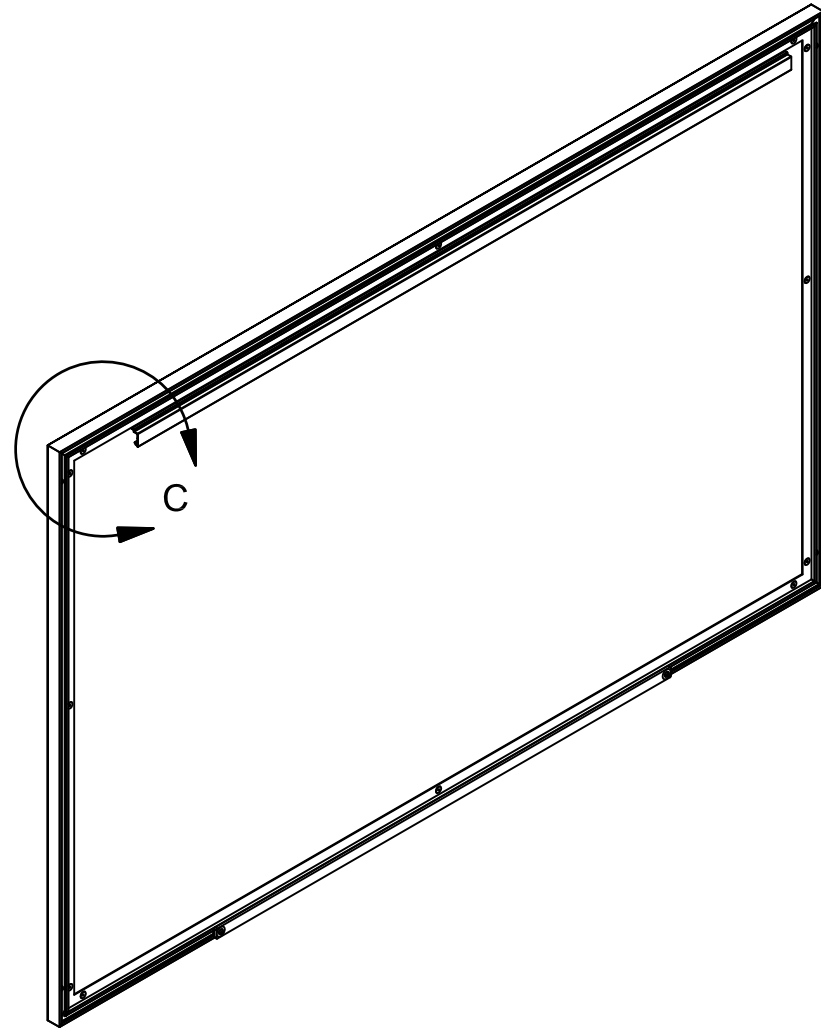

MODEL DESCRIPTION CIMA FIXED FRAME	MODEL # CIF094DNEVEWPX	SCREEN MATERIAL: NEVE	FRAME COLOR: VELUX	BATTEN COLOR: N/A	MOUNTING: WALL	APPROXIMATE WEIGHT: 30 LBS.	RESTRICTION: The Information contained in the proposal is confidential and proprietary to Stewart Filmscreen Corporation, shall not be disclosed beyond the client company, and shall not be duplicated, used, or disclosed in whole or in part for any purpose except to evaluate this proposal.
CUSTOMER ACCEPTANCE:	DATE:	DRAWING DATE: 5/24/2013	PERFORATION: PERFORADO	DRAWN BY: J. LAUB	SHEET: 3 OF 3	CONTROL(S): N/A	